

Part Number	Description
15 31-03228	Electric flywheel
16 13-27115	Special nut 16x1.25 dia24
17 27-57760	Special washer
18 10-84980	Oil seal 25x67x7x6mm
19 12-99561	Ball bearing 30x52x16
22 11-03720-8	Connecting rod Assy
23 16-16700	Head bearing 10x22x12
24 28-94120	Piston pin 10x25
25 25-86570	Piston pin 10x25
*25-86971	Piston pin 17x25
26 28-52200	Piston ring 47x25
*28-52170	Piston ring 47x25
27 28-86570-8	Camp piston 47x25
*28-86871-8	Camp piston 47x25
28 10-42600	Crank pin 18
41 11-64100	Special nut
42 29-07313-8	Primary drive with cup
43 10-00706	Crankshaft
44 12-46000	Woodruff key 18x7

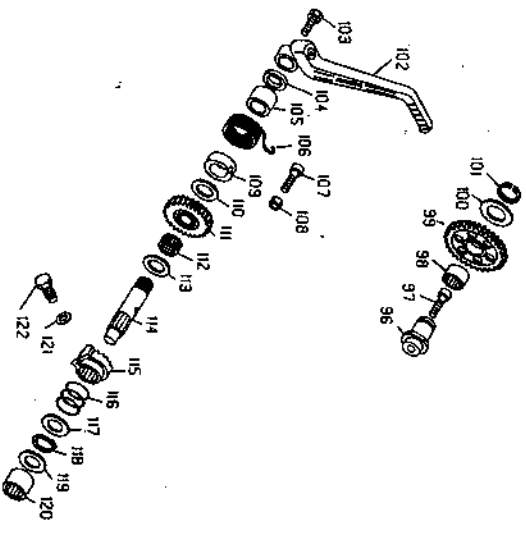

Part Number	Description
45 18-41500	Dowel 10x13
46 12-06328-0-33	Crankcase
47 31-59010	Screw 8x20
48 31-30020	Screw 5x25
49 12-69711-1-67	Magneto cover
50 31-34510	Screw 6x20
51 27-23470	Snubber pipe hose
52 29-00450	Magneto plug
53 16-53600	Gasket 10x22, 5x1
54 16-55732	Gasket 10x22, 5x1
55 18-71681	Inner clutch cover gasket
56 27-23470	Dowel 5x15
57 16-37010	Brusher pipe hose
58 12-62663-0-67	Internal clutch cover
59 16-53600	Gasket 10x22, 5x1
60 28-10290	Oil plug
61 29-10030	Oil plug
62 10-67340	Oil seal
63 12-63111-0-67	Clutch cover
64 31-34510	Screw 6x20

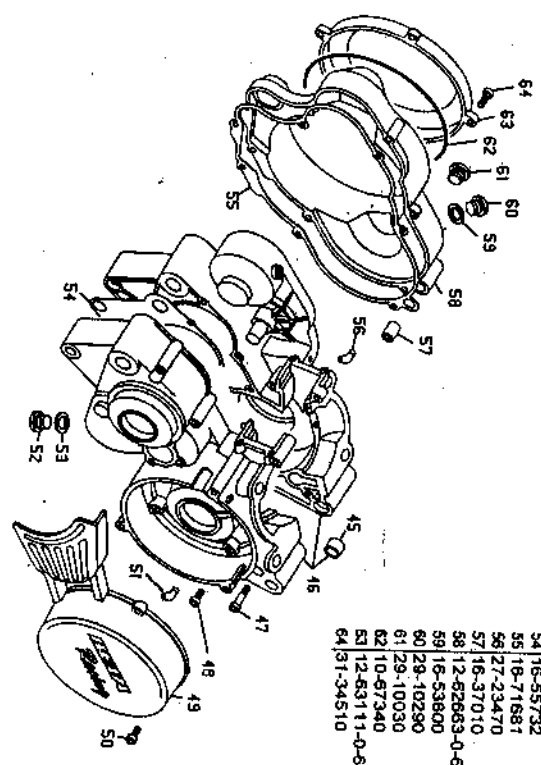

Part Number	Description
95 11-48010	Ball 0x16
96 25-53190	Driving gear pin
97 31-63890	Screw 6x20
98 18-16560	Head bearing 10x22x10
99 18-57823	Shaft gear
100 27-72860	Washer 18x27
101 28-25300	Sprocket 18E
102 21-55161	Kickstarter lever
103 11-54521	Ball 8x10 0x10
104 10-56015	Oil seal 10x22x4
105 11-31066	Internal bush 10x22x12.5
106 22-78972	Kickstarter spring
107 31-34510	Screw 6x20
108 13-11500	Nut 0x15
109 13-55230	Kickstarter spacer
110 27-87500	Washer 18x25
111 18-14632-4	Spacer gear
112 16-14300	Head bearing 10x20x10
113 27-67500	Washer 18x25
114 10-15133-8	Spacer shaft
115 22-14111-8	Kickstarter sleeve
116 22-36561	Spring
117 27-78630	Washer 20x20x4.5
118 28-25400	Sprocket 21E
119 27-84500	Washer 18x25
120 11-22400	Needle bearing 15x21x12
121 16-52000	Gasket 12x18x1.5
122 11-65501	Special ball

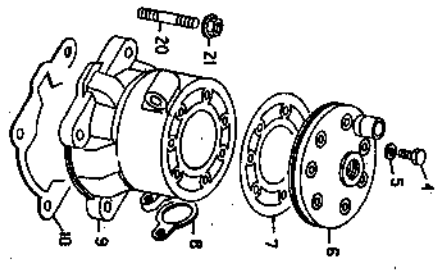

Part Number	Description
4 11-52425	Special bolt 1x3
5 27-45100	Cup washer 11x2x1.5
6 29-12091-0-57	Cylinder head 78
*29-12142-0-57	Cylinder head 78
7 10-67204	Cylinder head gasket
8 16-80700	Gasket
9 12-51842-0-57	Cylinder 47x25
*12-51862-0-57	Cylinder 47x25
10 16-81761	Cylinder 47x25
*16-87205	Cylinder crankcase gasket
20 25-98090	Cylinder-head gasket
21 13-17121	Stud ball 8x6
28 16-92550	Nut 10x special 0x10
30 21-15360	Valve gasket
31 25-59670	Valve pin
32 31-02140	Push bearing plate
33 25-57695	Engine manifold plate
34 10-67360	Oil seal
35 27-23492	Ball 10x20x10
36 27-40500	Washer 6x13
37 31-98010	Screw 6x25
38 15-15360	Camp 33x33
39 27-32100	Trochan cable guide
40 12-04893	Carburetor 1800x4

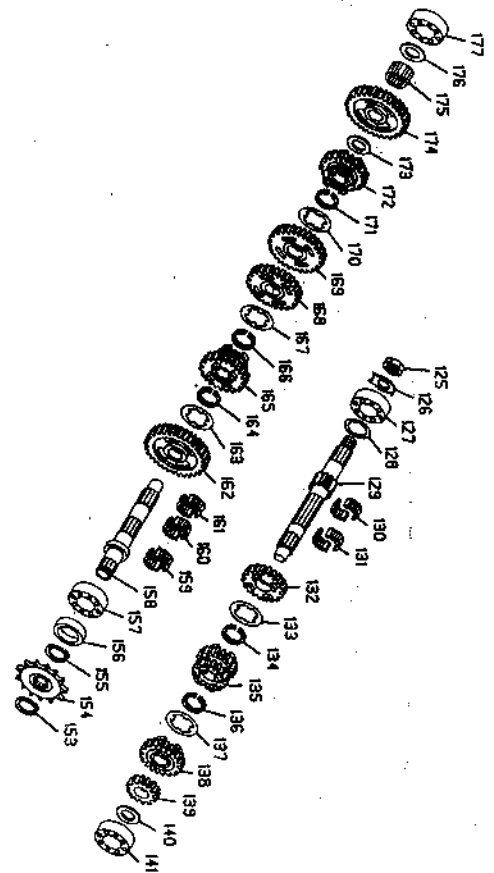

Part Number	Description
177	Shaft
178	Oil seal 12x22x5
179	Needle bearing 12x18x12
180	Washer 12x22
181	Special nut for 1.25x6 d12
182	Spring steel
183	Compressor selector shaft
184	Steel control fork arm
185	Sliding ball control fork arm
186	Selector shaft
187	Selector spring
188	Pin for retaining spring
189	Washer 12x22
190	Needle bearing 12x18x12
191	Screw 0.50 13x7C
192	Top Cam
193	Needle bearing 30x47x12
194	Washer 30x47x12
195	Cam
196	Washer 30x47x12
197	Needle bearing 30x47x12
198	Pin locating lever
199	Locking spring
200	Springs 10E
201	Selector pin 28.5
202	Selector pin 34.5
203	Selector pin 40.0
204	Selector pin 46.5
205	Selector pin 51.110
206	Selector pin 56.5
207	Selector pin 62.5

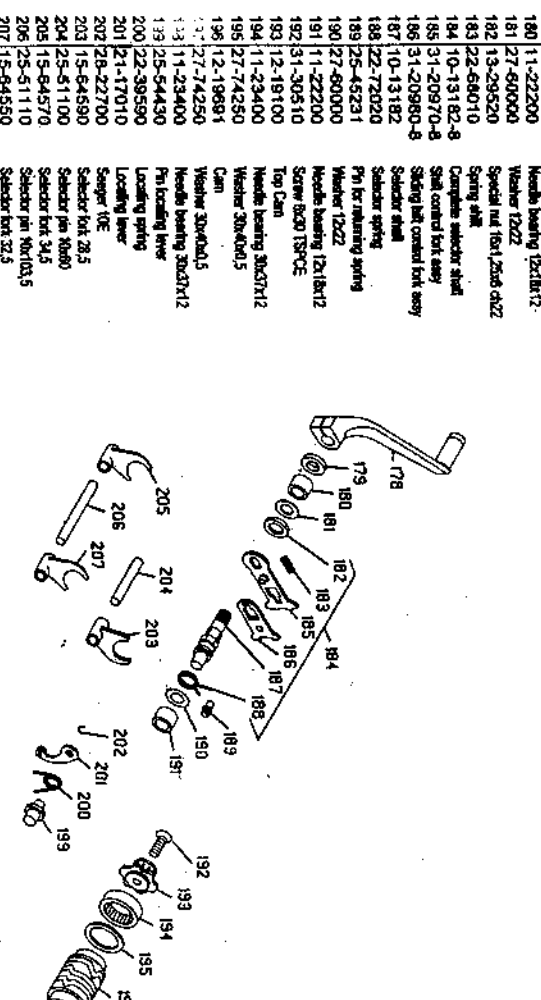

Part Number	Description
125	Special nut 16x1.25x7 d22
126	Special nut 14
127	Ball bearing 20x32x12 NTN
128	Washer 20x32x0.5
129	Washer 20x32x0.5
130	Needle bearing 16x21x10 Zmc
131	Needle bearing 16x21x10 Zmc
132	5TH gear meshball
133	Special washer
134	34 gear meshball
135	Special washer
136	3TH gear meshball
137	2ND gear meshball
138	Washer 15x25
139	Ball bearing 15x25x11
140	Special 1.11
141	Special 2.0E
142	Oil seal 20x32x7
143	Ball bearing 20x32x12 NTN
144	Lynchall
145	Needle bearing 16x22x10 Zmc
146	Needle bearing 16x22x10 Zmc
147	2nd gear Lynchall
148	Special washer
149	Springs 20SN
150	Springs 20SN
151	8TH gear Lynchall
152	Springs 20SN
153	Special washer
154	3RD gear Lynchall
155	Special washer
156	5TH gear Lynchall
157	Special washer
158	17x1.28-25.460
159	17x1.28-25.460
160	17x1.28-25.460
161	16x1.6-16.570
162	16x1.6-16.570
163	16x1.6-16.570
164	16x1.6-16.570
165	16x1.6-16.570
166	16x1.6-16.570
167	16x1.6-16.570
168	16x1.6-16.570
169	16x1.6-16.570
170	16x1.6-16.570
171	16x1.6-16.570
172	16x1.6-16.570
173	16x1.6-16.570
174	16x1.6-16.570
175	16x1.6-16.570
176	16x1.6-16.570
177	16x1.6-16.570

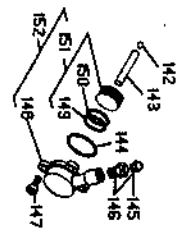
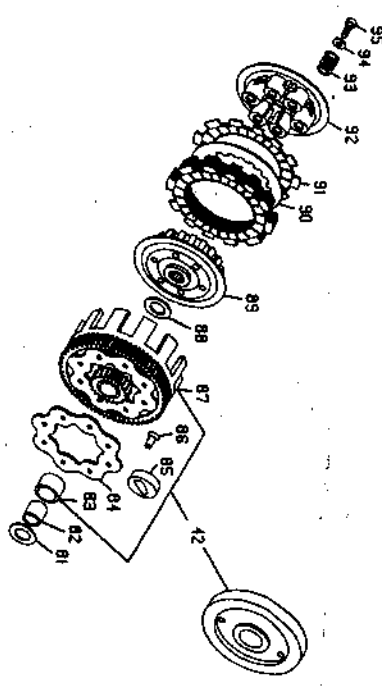
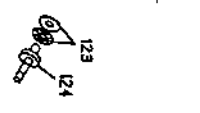

Part Number	Description
42	Primary drive with cap
43	Washer AS 20x32x1
44	Bush 20x32x0.5
45	Bushing first shaft block
46	Steel block
47	Rivet SC15 TSP
48	Clutch housing
49	Special washer
50	Clutch center
51	Steel plate
52	Clutch plate
53	Pressure plate
54	Clutch spring
55	Washer 8x18
56	Ball 0x18
57	Needle bearing 16x22x10
58	Special rod
59	Ball 0x18
60	Oil seal 20.32x1.5
61	Rear plate head
62	Breaker pipe
63	Screw 5x17
64	Clutch pump cover 428
65	Oil seal 23.52x1.75
66	Oil seal 21.86x2.82
67	Clutch pump piston
68	Clutch pumpassy 628

2004 BETA Rev 3 250/270

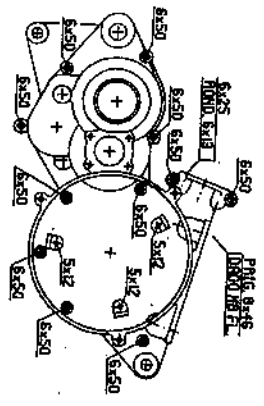
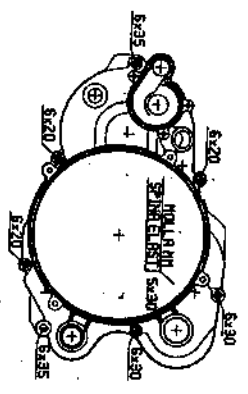
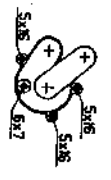
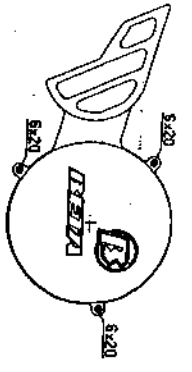
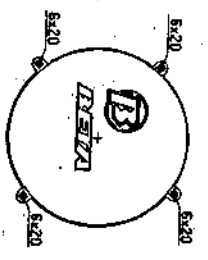

Pos Number	Description
12-00734-8	Complete gearbox
22-05053-8	Complete backdrive
28-06871-8	Kit oil seal
28-08083-8	Kit gearbox
28-08084-8	Kit gearbox

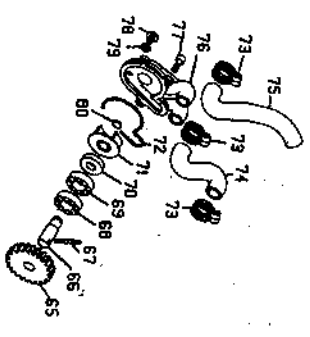
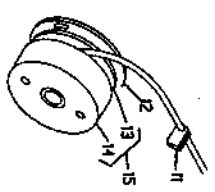
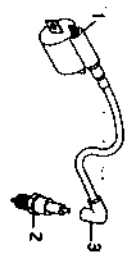

Pos Number	Description
1 11-20681	HT coil
2 12-25210	Spark plug NYCC
3 27-13550	Spark plug protector
11 18-33571	Governor
12 25-80768	Prism silicone
13 28-97811	Shaft steel/steel/nylon
14 27-00363	Rotor cap
15 31-03228	Elastic flywheel
85 18-82640	Water pump gear
86 18-82641	Water pump gear
87 27-84100	Counter shaft
88 12-93420	Steel roller 8x12
89 12-93410	Ball bearing 10x26
70 10-44610	Ball bearing 10x26 FRS1
71 31-21840	Oil seal 10x18x4
72 10-87360	Pump fan
73 15-15230	Oil seal
74 29-15884	Clamp 1x25
75 28-15883	Cylinder water pump hose
76 12-87931-Q-67	Water pump reducer tube
77 31-30000	Pump cover
78 31-30480-0-51	Screw Sx18
79 16-47500	Screw Sx18
80 28-22860	Gasket 6x12x15
	Sprocket

2004 Rev 3

250/270 cc

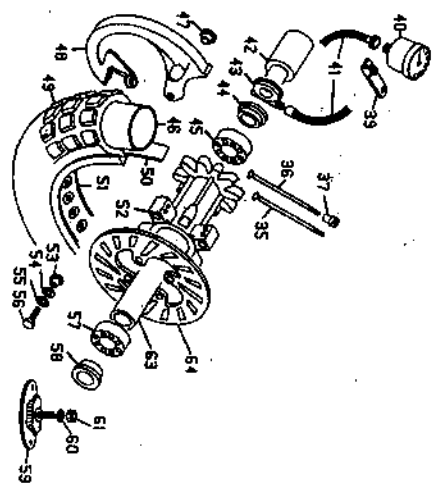

Pos Number	Description
35	Spoke 3x25x C189
36	Spoke 3x25B C189
37	Spoke 3x25-10100
38	Spoke 3x25-87231
40	Speedometer
41	Speedometer cable
42	Front wheel axle
43	Speed driver
44	UH and FH front hub spacer
45	Ball bearing 20x62x12
46	Tube 2.75x21 WICH-ELEM
47	Spacer
48	Front brake disk cover
49	Tim 2.75x21
50	Ball bearing 21x17x62
51	Front hub with ball bearing
52	Spacer
53	Cap spring
54	Washer 6x18 5x1
55	Washer 6x18 5x1
56	Ball bearing 20x62x12
57	UH and FH front hub spacer
58	Tim washer
59	Nut B56
60	Front hub inner spacer
61	Front hub disk
62	Front hub disk
63	Front hub disk
64	Front hub disk

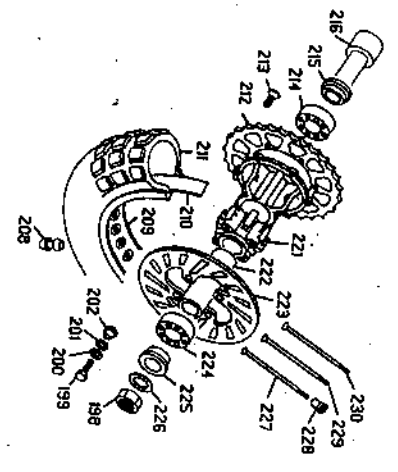

Pos Number	Description
198	Nut B47 5
199	Ball B20
200	Washer 6x18 5x1
201	Cap spring
202	Spacer
203	Tim washer
204	Pin MONROE TR21 15x62
205	Blind
206	Pin MONROE TR21 15x62
207	Pin MONROE TR21 15x62
208	Pin MONROE TR21 15x62
209	Pin MONROE TR21 15x62
210	Pin MONROE TR21 15x62
211	Pin MONROE TR21 15x62
212	Pin MONROE TR21 15x62
213	Pin MONROE TR21 15x62
214	Pin MONROE TR21 15x62
215	Pin MONROE TR21 15x62
216	Pin MONROE TR21 15x62
217	Pin MONROE TR21 15x62
218	Pin MONROE TR21 15x62
219	Pin MONROE TR21 15x62
220	Pin MONROE TR21 15x62
221	Pin MONROE TR21 15x62
222	Pin MONROE TR21 15x62
223	Pin MONROE TR21 15x62
224	Pin MONROE TR21 15x62
225	Pin MONROE TR21 15x62
226	Pin MONROE TR21 15x62
227	Pin MONROE TR21 15x62
228	Pin MONROE TR21 15x62
229	Pin MONROE TR21 15x62
230	Pin MONROE TR21 15x62

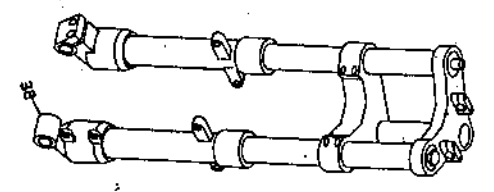

Pos Number	Description
6	Upper fork
7	Lower fork
8	Upper fork
9	Lower fork
10	Upper fork
11	Lower fork
12	Upper fork
13	Lower fork
14	Upper fork
15	Lower fork
16	Upper fork
17	Lower fork
18	Upper fork
19	Lower fork
20	Upper fork
21	Lower fork
22	Upper fork
23	Lower fork
24	Upper fork
25	Lower fork
26	Upper fork
27	Lower fork
28	Upper fork
29	Lower fork
30	Upper fork
31	Lower fork
32	Upper fork
33	Lower fork
34	Upper fork
35	Lower fork
36	Upper fork
37	Lower fork
38	Upper fork
39	Lower fork
40	Upper fork
41	Lower fork
42	Upper fork
43	Lower fork
44	Upper fork
45	Lower fork
46	Upper fork
47	Lower fork
48	Upper fork
49	Lower fork
50	Upper fork
51	Lower fork
52	Upper fork
53	Lower fork
54	Upper fork
55	Lower fork
56	Upper fork
57	Lower fork
58	Upper fork
59	Lower fork
60	Upper fork
61	Lower fork
62	Upper fork
63	Lower fork
64	Upper fork

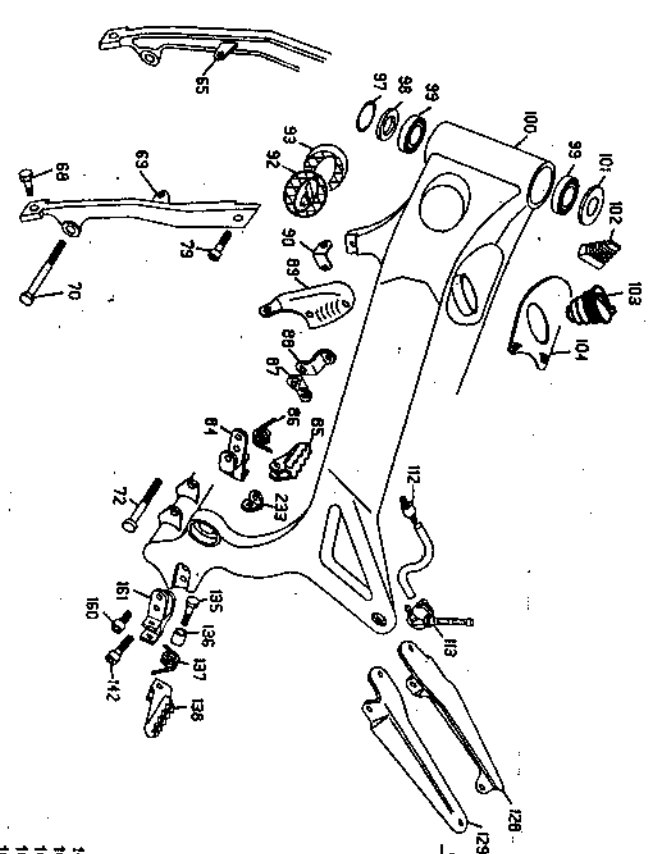
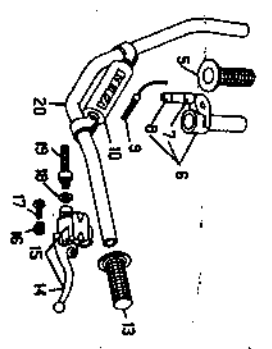

Pos Number	Description
65	RH connecting frame rod
66	Ball B216 4x10
67	UH connecting frame rod
68	Ball B216 4x10
69	UH connecting frame rod
70	Ball B216 4x10
71	UH connecting frame rod
72	Ball B216 4x10
73	UH connecting frame rod
74	Ball B216 4x10
75	UH connecting frame rod
76	Ball B216 4x10
77	UH connecting frame rod
78	Ball B216 4x10
79	UH connecting frame rod
80	Ball B216 4x10
81	UH connecting frame rod
82	Ball B216 4x10
83	UH connecting frame rod
84	Ball B216 4x10
85	UH connecting frame rod
86	Ball B216 4x10
87	UH connecting frame rod
88	Ball B216 4x10
89	UH connecting frame rod
90	Ball B216 4x10
91	UH connecting frame rod
92	Ball B216 4x10
93	UH connecting frame rod
94	Ball B216 4x10
95	UH connecting frame rod
96	Ball B216 4x10
97	UH connecting frame rod
98	Ball B216 4x10
99	UH connecting frame rod
100	Ball B216 4x10
101	UH connecting frame rod
102	Ball B216 4x10
103	UH connecting frame rod
104	Ball B216 4x10
105	UH connecting frame rod
106	Ball B216 4x10
107	UH connecting frame rod
108	Ball B216 4x10
109	UH connecting frame rod
110	Ball B216 4x10
111	UH connecting frame rod
112	Ball B216 4x10
113	UH connecting frame rod
114	Ball B216 4x10
115	UH connecting frame rod
116	Ball B216 4x10
117	UH connecting frame rod
118	Ball B216 4x10
119	UH connecting frame rod
120	Ball B216 4x10
121	UH connecting frame rod
122	Ball B216 4x10
123	UH connecting frame rod
124	Ball B216 4x10
125	UH connecting frame rod
126	Ball B216 4x10
127	UH connecting frame rod
128	Ball B216 4x10

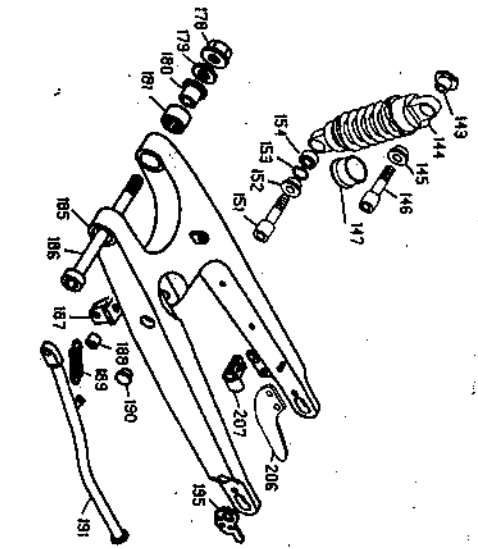

Pos	Number	Description
143	13-21847	Nut special shock absorber
144	10-03717	Shock absorber
145	11-28812	Bush special bearing
146	11-65022	Special ball shock absorber
147	15-39100	Leg protection
151	11-65022	Special ball shock absorber
152	11-28811	Bush special bearing
153	10-67361	Oil-RN1 spring arm
154	28-69021	Synthetic oil
178	13-28510	Special nut 18x1.25
179	27-67500-0-50	Washer 16x25x8
180	13-49200	Spacer
181	11-23000	Headle bearing 22x28x18
185	15-48594-8	Shafting arm set
186	25-55770	Stem spindle
187	28-98575-0-66	Stem
188	13-46300	Special stand
189	22-47024	5/8" shaft spring
190	29-10593	Rubber plug, stem
191	12-38934-0-56	Stand
195	29-11880	Chain tensioner
206	25-88565	Rear sprocket protection
207	15-14300	Chain

2004
Rev 3
250/270cc

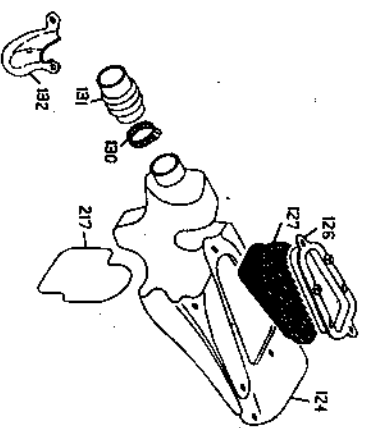

Pos	Number	Description
115	16-75910	Gaslet frame
116	12-73213-0-97	At filter cover
124	28-12746-0-58	At filter box
125	28-88088-0-58	Filter bracket
127	15-26053	At filter
130	15-15360	Clamp 33x53
131	22-13641	At filter
132	13-36050	Rubber absorber shock
217	25-24412	Filter box nut/guard

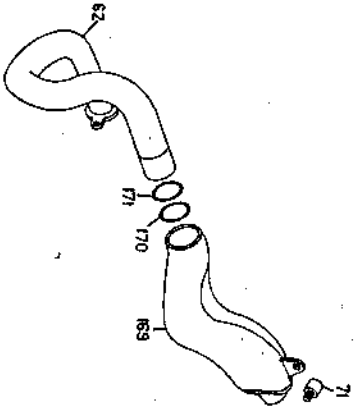

Pos	Number	Description
62	28-16251	Exhaust tube
71	28-91942	Smart block
121	16-02504	Supporting ball for muffler
122	12-54321-0-58	Spacer terminal
123	12-68413	Muffler cover
188	22-03355	Muffler
170	10-67100	Oil seal 62.07x2.62 yphen
171	10-67100	Oil seal 62.07x2.62 yphen
218	25-94585	Inner component, silencer
219	10-68680	Oil seal 28.25x2.62 yphen
220	10-68680	Oil seal 28.25x2.62 yphen
231	28-91868	Silencer complete
232	16-29602	Silencer grommet

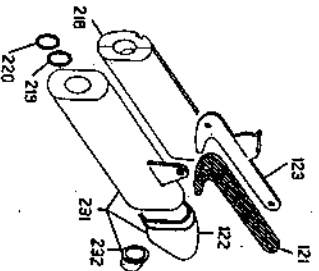

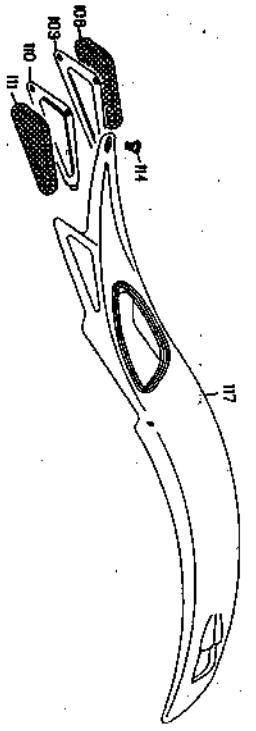

2004
REV 3
250/270cc



Part Number	Description
27	2.5-1.5190-0-97 Foot fender
28	28-98277 Foot fender bracket
29	15-14600 Clamp 10x15
108	27-28490 Rear fender RH pad
109	12-55784 Capstern grill right rear fender
110	12-55780 Capstern grill left rear fender
111	27-28491 Rear fender LH pad
114	31-30530 Screw 6x12
117	25-19687-0-97 Rear fender

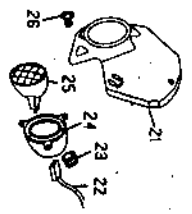

Part Number	Description
11	11-11111 Electric equipment
12	12-12222 Headlight holder
21	22-28693-0-97 Electric equipment
22	18-01513 Electric equipment
23	28-91500 Sheet stock
24	12-03160-0-59 Front hand light cover
25	21-16750 Headlight lamp
26	31-29860 Screw 5x16
73	14-01030 Electric fan
74	18-01861 Electric equipment
75	29-11959 Terminal 5000
76	16-48500 Gasket locknut copper
82	27-43000 Rubber washer 620x3
83	31-50520 Screw 6x16
96	10-08222 Horn
105	18-23325 Coil unit cutback
106	12-41825 Regulator
107	27-28092 Rear light lamp holder
118	25-91760 Warning light 12V-4W
120	15-01821 Rear light
125	18-01423 Electric equipment

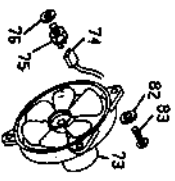

Part Number	Description
11	13-36640 Switch
12	18-01672 Electric equipment
21	22-28693-0-97 Headlight holder
22	18-01513 Electric equipment
23	28-91500 Sheet stock
24	12-03160-0-59 Front hand light cover
25	21-16750 Headlight lamp
26	31-29860 Screw 5x16
73	14-01030 Electric fan
74	18-01861 Electric equipment
75	29-11959 Terminal 5000
76	16-48500 Gasket locknut copper
82	27-43000 Rubber washer 620x3
83	31-50520 Screw 6x16
96	10-08222 Horn
105	18-23325 Coil unit cutback
106	12-41825 Regulator
107	27-28092 Rear light lamp holder
118	25-91760 Warning light 12V-4W
120	15-01821 Rear light
125	18-01423 Electric equipment

Part Number	Description
139	12-94863 Cover dash
140	12-06770 Chair seat p 100
141	22-11220 Connecting link 50x14
142	22-81112 Spring
149	16-22500 Chair lens block
150	25-25963 Sling block
172	16-23320 Bumper
173	12-32182 Bumper rubber
182	31-64070 Screw 6x25
183	29-10082-0-52 Sling block
184	31-30540 Screw 6x16
182	16-29492 Greenet
193	31-73000 Screw 4x6
194	12-88052-0-52 Lower rear deck valve cover

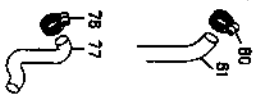
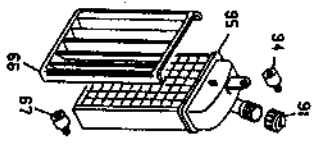
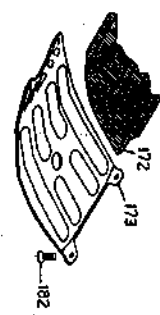

Part Number	Description
66	16-45542-1-67 Radiator protection
67	28-91842 Sheet block
77	28-15864 Water pump radiator tube
78	15-15230 Clamp 15x25
80	15-15230 Clamp 15x25
81	29-15881 Radiator tube
81	28-01821 Water tank cover
84	28-91841 Sheet block
85	27-23632 Radiator



Part Number	Description
12	43030 Sport plug key
13	33816 Compactly stacks REV13 TM
13	33818-1 Decal front fender REV13 TM
13	33815-2 Decal rear fender REV13 TM
13	33815-3 Decal headlight holder REV13
13	33815-4 Decal weight arm REV13
13	33818-5 Decal star cover REV13
27	02563-0-57 Front wheel
27	02563-4-57 Front wheel ass.
27	04898-0-57 Rear wheel
27	04898-4-57 Rear wheel ass.
28	92920 Rear view mirror